

# Optimisation of a Supercritical Carbon Dioxide (sCO<sub>2</sub>) Concentrated Solar Power (CSP) System

Ruan van der Westhuizen

Prof Albert Groenwold, Prof Johan van der Spuy, Mr Robert Dobson

Solar Thermal Energy Research Group (STERG)

6<sup>th</sup> Annual STERG Symposium  
Stellenbosch, South Africa  
18 July 2019

# Preface



- $s\text{CO}_2$  Brayton cycle is an alternative to the steam Rankine cycle
- $s\text{CO}_2$  can be operated with different heat sources at small and large power scales
- $s\text{CO}_2$  offers better thermal efficiency, simpler cycle layouts and smaller equipment
- $s\text{CO}_2$  industry is in its infancy

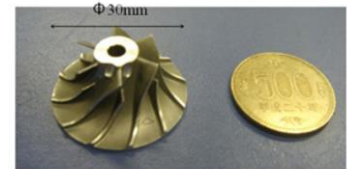
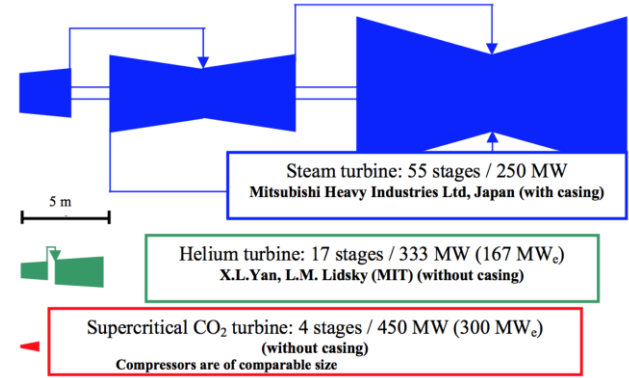

Centrifugal compressor

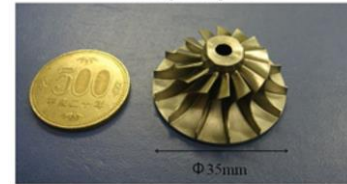

Radial inflow turbine

# Contents

---



1. Motivation and Objectives
2. System Configuration
3. Investigation into sCO<sub>2</sub> Turbomachinery
4. General Findings

# Motivation and Objectives



Design-point **vs** Off-design & Control

System Level **vs** Component Details

Analysis **vs** Optimisation



1. Development of a versatile analytical model for the system
2. Development of a computational architecture
3. Development of an application strategy and workflow

# Objectives



1. Pareto-optimisation studies to show trade-offs between design variables
2. Optimise the system's design for the maximum thermal efficiency under given constraints
  - net power output
  - DNI level and ambient conditions
3. Optimise the system's control strategy for the maximum energy production on a given day

# System Configuration

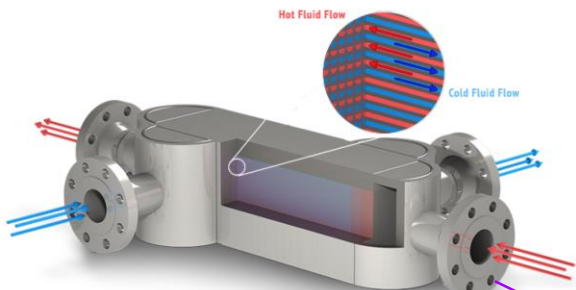

Solar Receiver

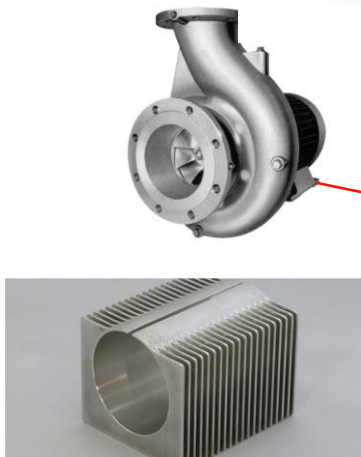

Compressor

Recuperator

Turbine

Heat Sink

Thermal Energy Storage System

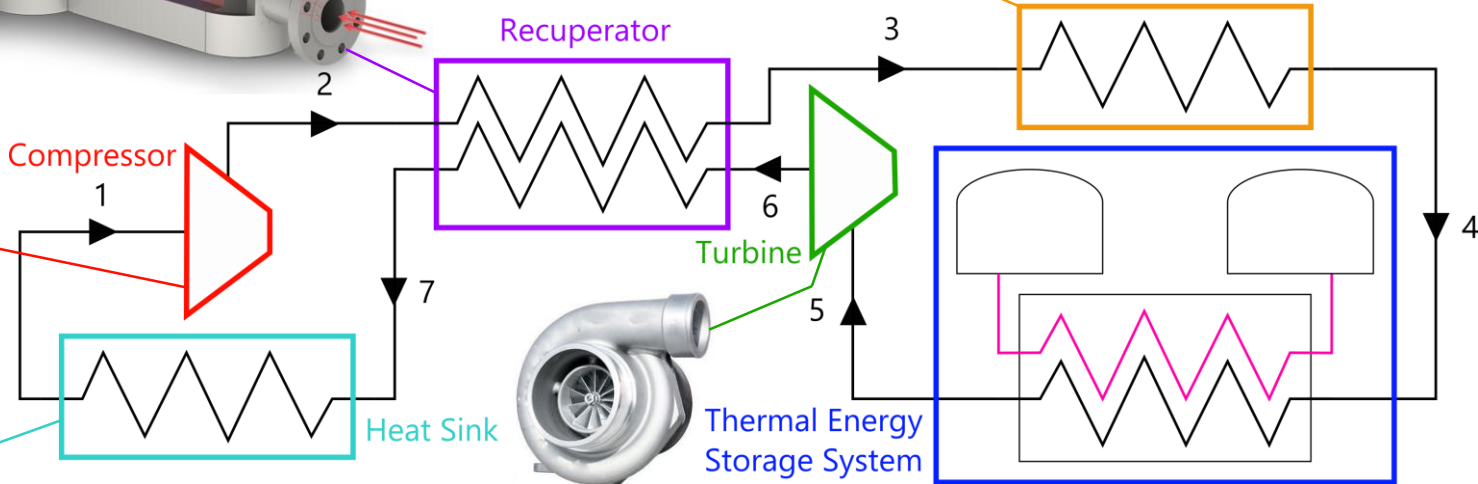

# Thermodynamics of sCO<sub>2</sub> Turbomachinery

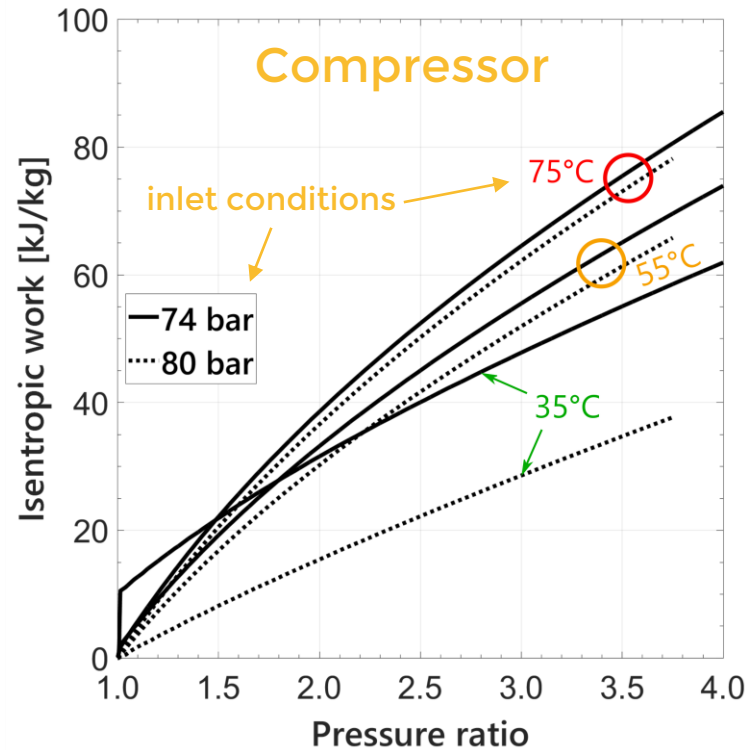
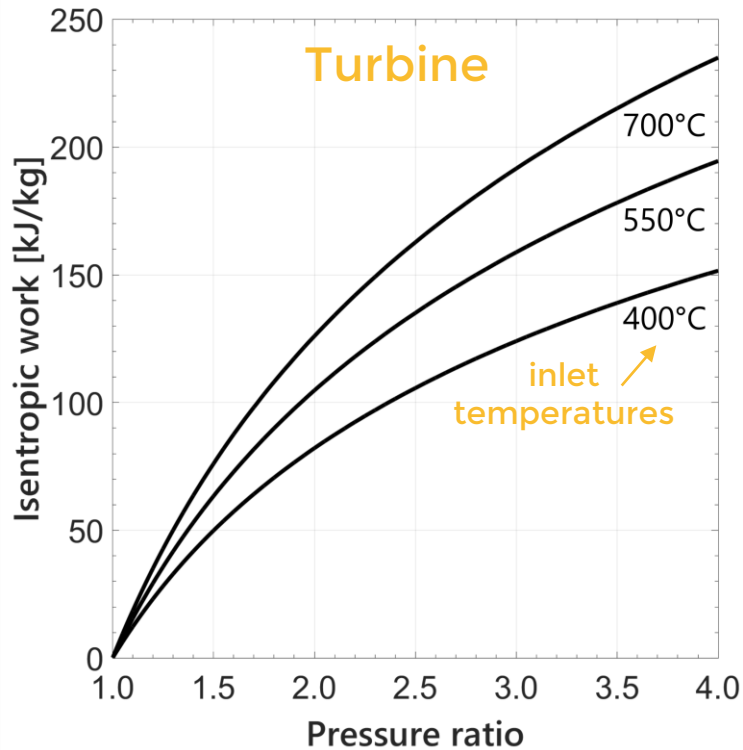

# Geometry of a Radial Turbomachine Stage



## conservation of mass

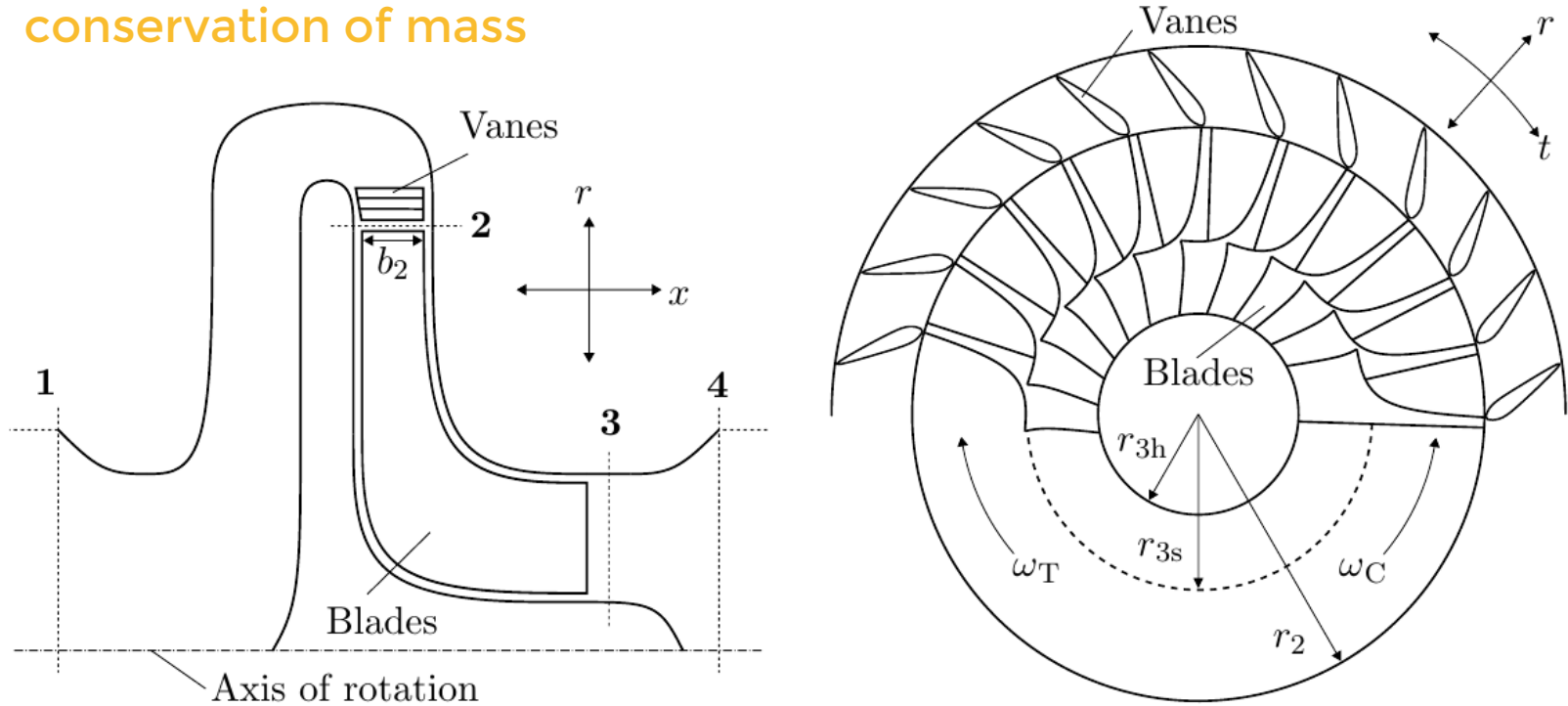



# Velocity Triangles



## conservation of momentum

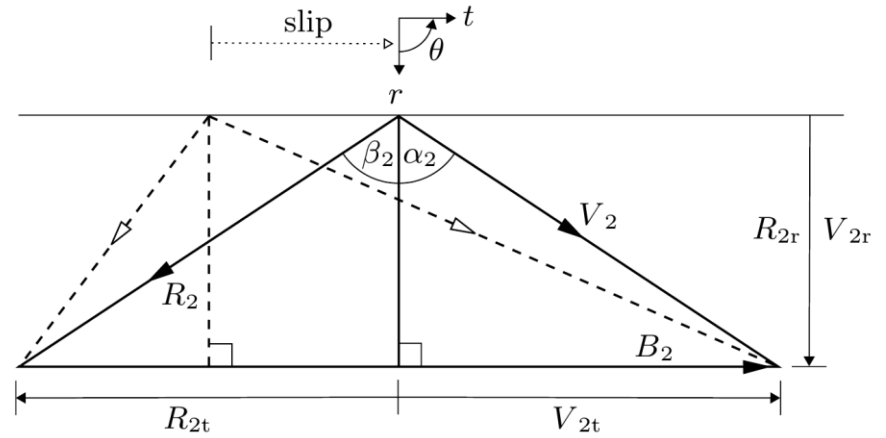
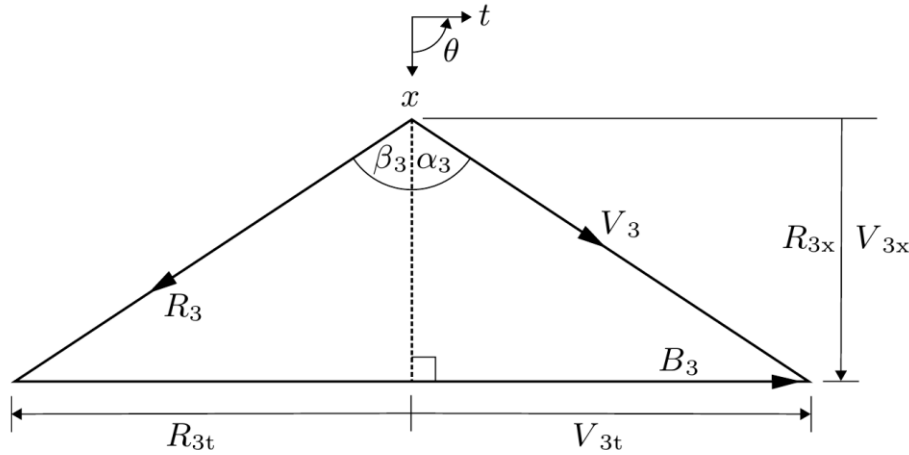

shows the relationship between the

- blade velocity (**B**),
- absolute velocity (**V**), and
- relative velocity (**R**)

$$\sigma = 1 - \frac{V_{2t}}{V_{2t}'}$$



slip factor

# Conservation of Energy



$\dot{W}_{\text{fluid}} = M\omega \longrightarrow$  “internal” transfer of momentum

$\dot{W}_{\text{thermodynamic}} = \dot{m}(h_{02} - h_{03}) \longrightarrow$  “external” measurements

$\dot{W}_{\text{parasitic}} = \left| \dot{W}_{\text{thermodynamic}} - \dot{W}_{\text{fluid}} \right| \longrightarrow$  e.g., clearance, windage

$h_{01} = h_{02}$   
 $h_{03} = h_{04} \longrightarrow$  nozzle and diffuser sections

# Loss Coefficients



$$\zeta_R = \frac{h_0 - h_{0s}}{\frac{1}{2}(R_2)^2}$$

$$\zeta_P = \frac{w_{\text{parasitic}}}{\frac{1}{2}(R_2)^2} = \frac{\dot{W}_{\text{parasitic}}}{\frac{1}{2}\dot{m}(R_2)^2}$$

$$\eta_D = \frac{\frac{P_{\text{out}} - P_{\text{in}}}{P_{0,\text{in}} - P_{\text{in}}}}{1 - (AR)^2}$$

- Function of design
- Function of operating conditions
- Determine numerical values using
  - Experiments
  - CFD
- Universal correlations?

# Introduction to *CompAero*

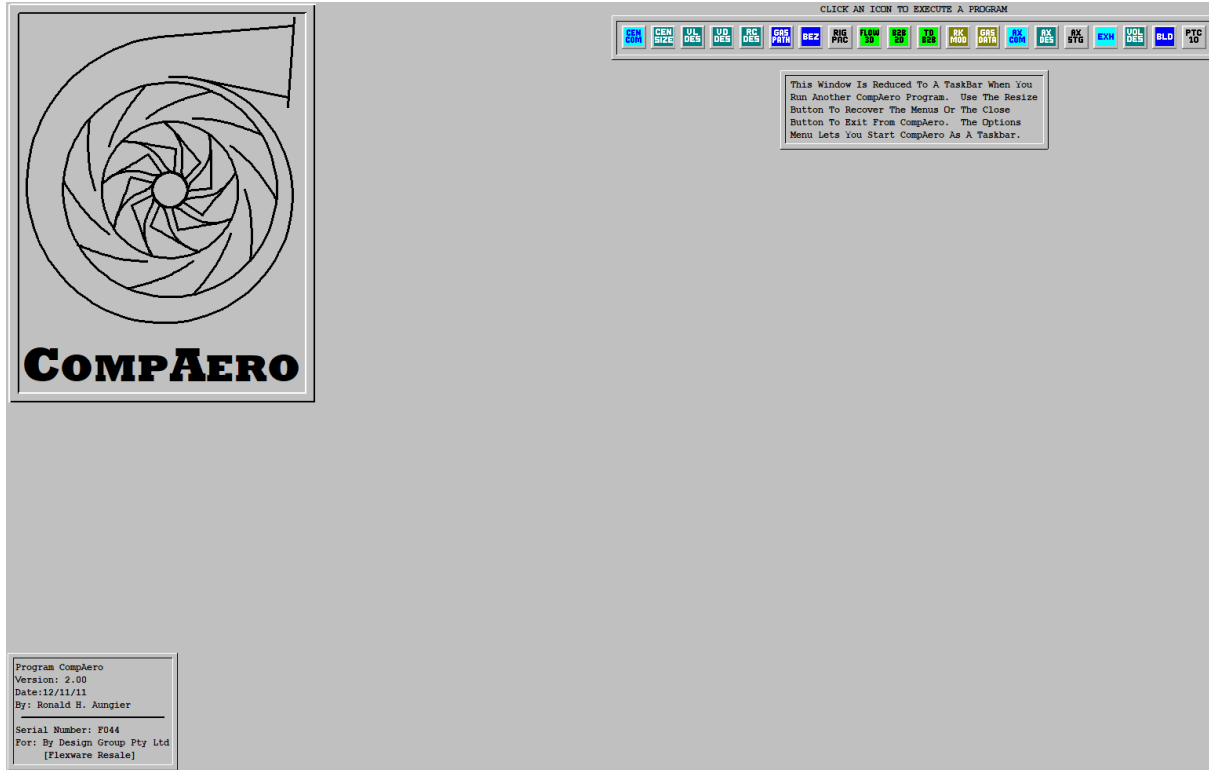

# Introduction to *CompAero*



Enter/Edit Case Title  
**DesignType1**

Impeller Blade Style: Full-Inducer

Diffuser Type: Conventional Vaned Diffuser

Impeller Cover Style: Open Impeller

Discharge Type: Elliptical Volute

Impeller Splitter Blades?: No

Performance Type: Adiabatic

Inlet Total Temperature (deg K) = 300

Inlet Total Pressure (kPa) = 130

CHOOSE TWO OF THE PARAMETERS BELOW TO BE SPECIFIED

CHOOSE AT LEAST ONE OF THESE TWO

- Rotation Speed (rpm)
- Tip Diameter

ONLY ONE OF THESE THREE CAN BE CHOSEN

- Impeller Tip Speed
- Rotational Mach Number
- (Air) Equivalent Tip Speed

Rotation Speed (rpm) = 20000

Rotational Mach Number = 1.305

# Introduction to *CompAero*



```

Impeller Geometry

rms inlet blade angle ..... 29.9683
rms inlet diameter ..... 0.13848
Inlet passage width ..... 0.01974
Hub inlet diameter ..... 0.11733
Shroud inlet diameter ..... 0.15681
Hub inlet blade angle ..... 33.6824
Shroud inlet blade angle .... 26.8081
Inlet rms cone angle ..... 4.79044
Inlet rms b/Rc ..... 0.48685
Inlet rms blade thickness ... 0.00092
Inlet fillet blockage ..... 0.00000
Meridional passage length ... 0.11766
Splitter passage length .... 0.00000
Disk diameter ..... 0.33523
Disk/housing clearance ..... 0.00394
Tip width (with extension) .. 0.00000
Throat rms blade angle ..... 27.3060
Inlet net area ..... 0.00783
Blade passage length ..... 0.19380
Eye shroud diameter ..... 0.15681
Slip factor ..... 0.89346
    
```

```

Loading Parameter, DW/W 1.0782 1.0480 1.0171 0.9843 0.9395 0.8494
Throat A/A* ..... 1.2926 1.2160 1.1478 1.0868 1.0319 1.0065
Throat Blockage ..... 0.0348 0.0353 0.0358 0.0363 0.0369 0.0371
Inlet rms Cm ..... 83.019 88.824 94.768 100.87 107.15 110.40
Inlet rms Cu ..... 0.0000 0.0000 0.0000 0.0000 0.0000 0.0000
Inlet rms C ..... 83.019 88.824 94.768 100.87 107.15 110.40
Inlet rms W ..... 199.38 201.87 204.55 207.45 210.58 212.25
Inlet rms M' ..... 0.7458 0.7558 0.7666 0.7783 0.7909 0.7977
Inlet rms Pt ..... 130.00 130.00 130.00 130.00 130.00 130.00
Inlet rms P ..... 122.23 121.13 119.94 118.65 117.25 116.50
Shroud Incidence ..... 0.1101 -1.475 -3.051 -4.618 -6.179 -6.965
Inlet Shroud Cm ..... 103.23 110.45 117.84 125.42 133.23 137.28
Inlet Shroud W ..... 229.76 233.09 236.68 240.55 244.71 246.94
Inlet Shroud M' ..... 0.8629 0.8767 0.8917 0.9079 0.9254 0.9349
Hub Incidence ..... 11.440 10.050 8.6575 7.2599 5.8559 5.1430
Inlet Hub Cm ..... 62.810 67.202 71.699 76.315 81.067 83.526
Inlet Hub W ..... 165.93 167.64 169.50 171.50 173.67 174.83
Inlet Hub M' ..... 0.6189 0.6256 0.6328 0.6406 0.6491 0.6537
Tip Flow Coeff ..... 0.1172 0.1246 0.1323 0.1407 0.1531 0.1830
Tip Cm ..... 49.224 52.337 55.545 59.090 64.270 76.747
Tip Cu ..... 314.51 311.60 308.51 305.05 299.62 285.67
Tip C ..... 318.34 315.96 313.47 310.72 306.44 295.80
Tip M ..... 1.0307 1.0238 1.0166 1.0087 0.9964 0.9659
Tip Flow Angle ..... 8.8953 9.5347 10.206 10.963 12.107 15.038
Tip Pt ..... 796.91 788.76 779.04 764.88 727.70 598.63
Tip Tt ..... 466.05 464.35 462.58 460.63 457.63 450.12
Tip P ..... 426.98 425.89 424.05 420.04 405.10 344.47
Tip V ..... 0.1787 0.1788 0.1793 0.1806 0.1866 0.2174
Distortion Factor ..... 1.6607 1.6203 1.5842 1.5515 1.5149 1.4590
Work Coeff ..... 0.7849 0.7762 0.7672 0.7573 0.7426 0.7065
    
```

# Correlations from *CompAero*

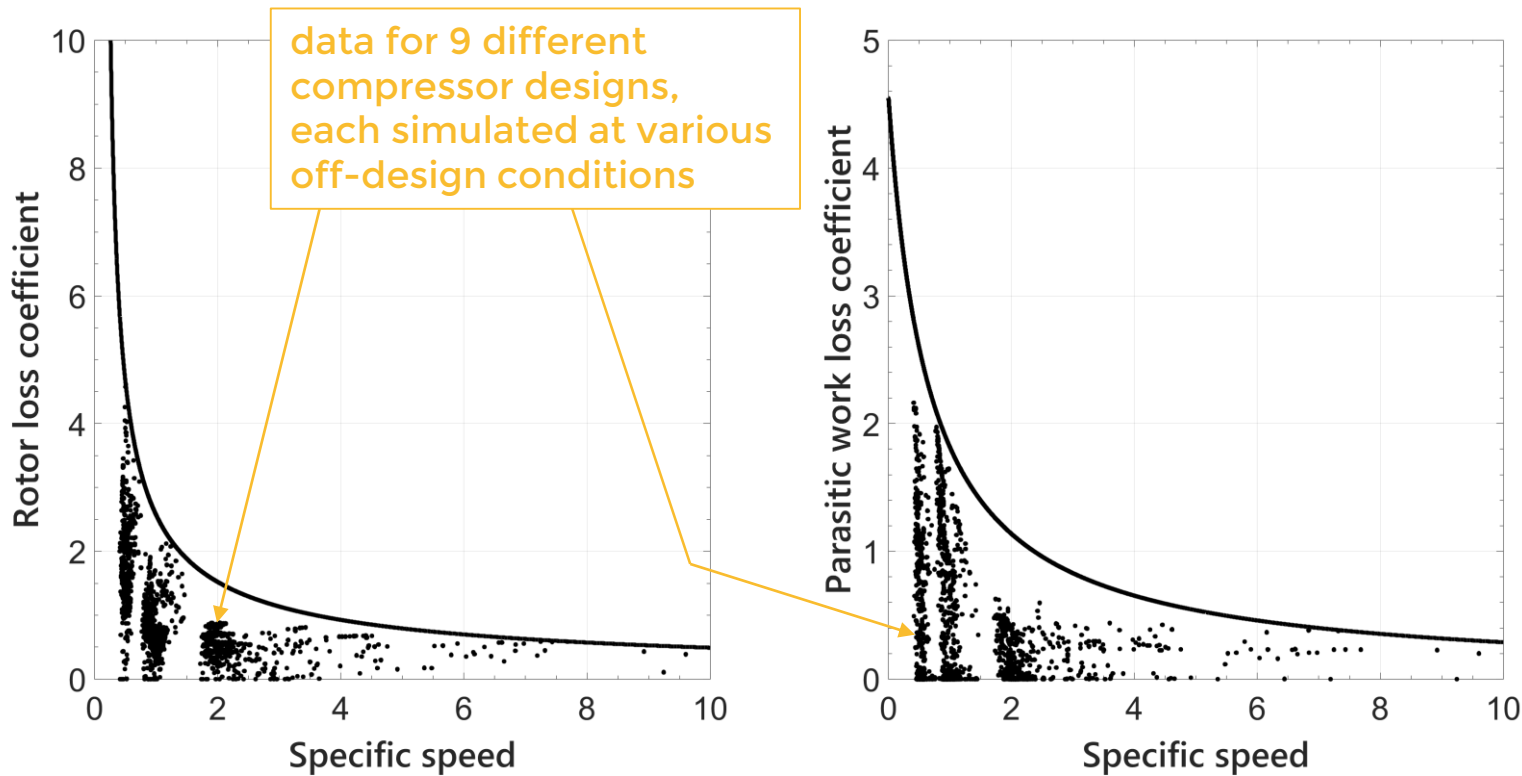

# Correlations from *CompAero*

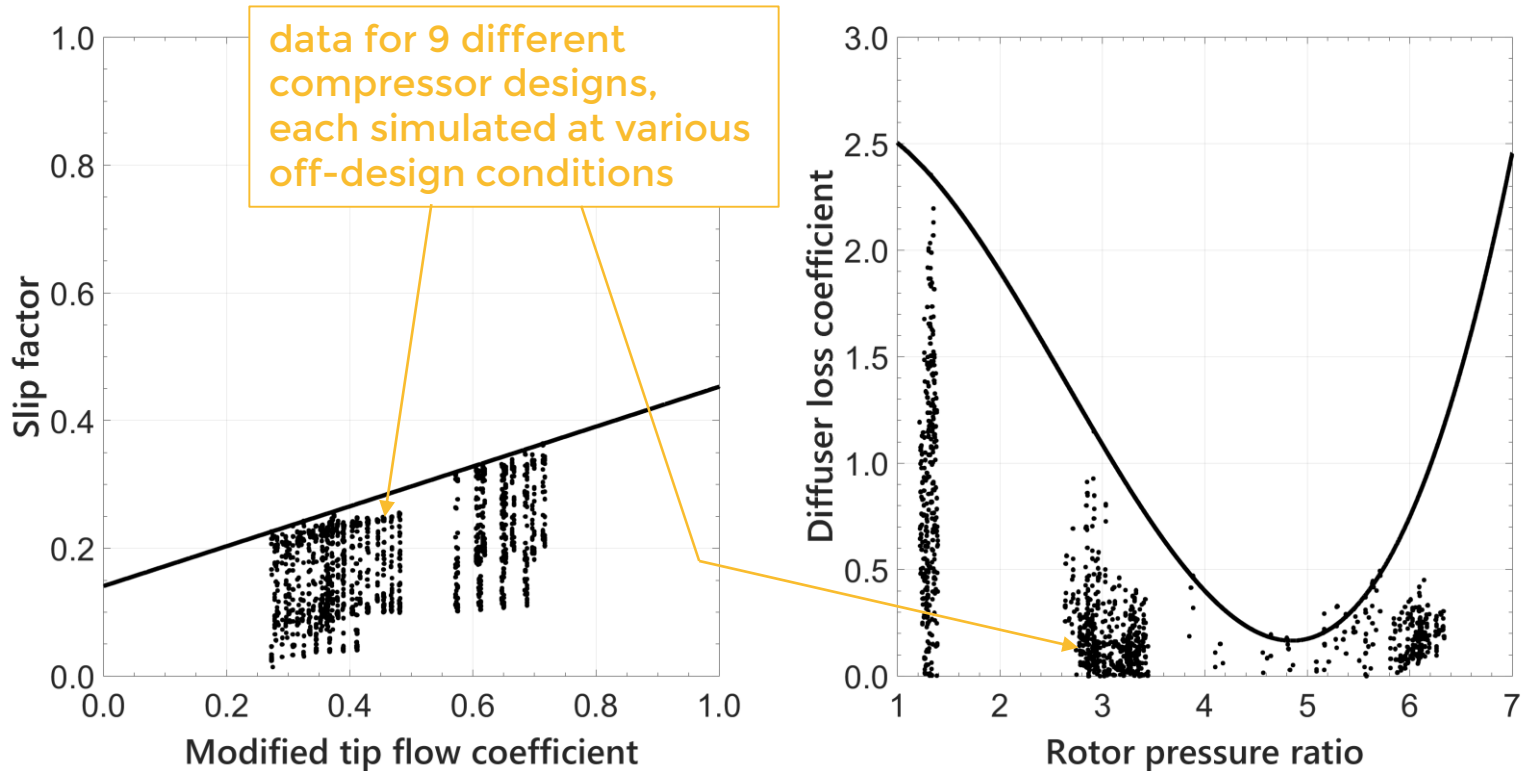



# Structure of an Optimisation Problem



Objective Function



Minimise  $f(\mathbf{x})$ , subject to

Equality Constraints

→  $g_i(\mathbf{x}) = 0 \quad i = 1, 2, \dots, m$

Inequality Constraints

→  $h_j(\mathbf{x}) \leq 0 \quad j = 1, 2, \dots, r$

Design Variables



$$\mathbf{x} = \begin{bmatrix} x_1 \\ x_2 \\ \vdots \\ x_n \end{bmatrix}$$

$\mathbf{x} \in \mathbb{R}^n$

$$\check{\mathbf{x}} \leq \mathbf{x} \leq \hat{\mathbf{x}}$$

Upper Bounds



Lower Bounds



# Compressor Optimisation Results

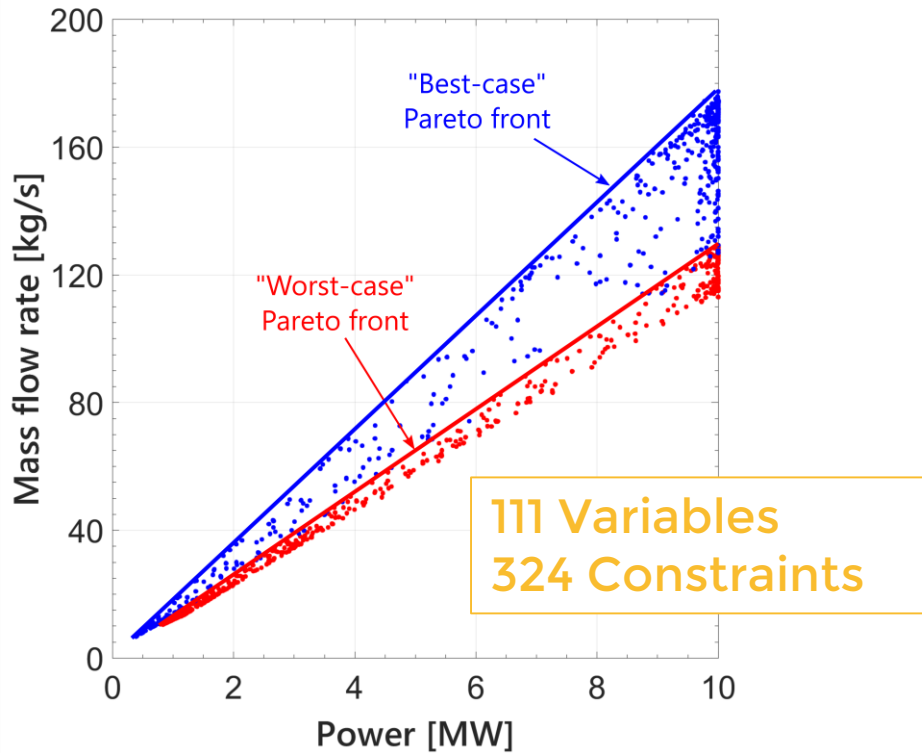
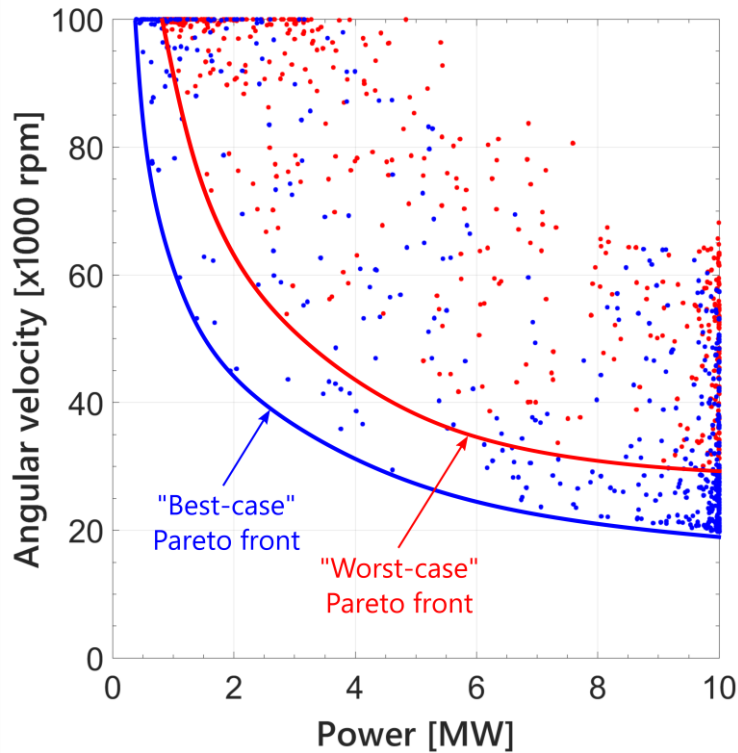

# Compressor Optimisation Results

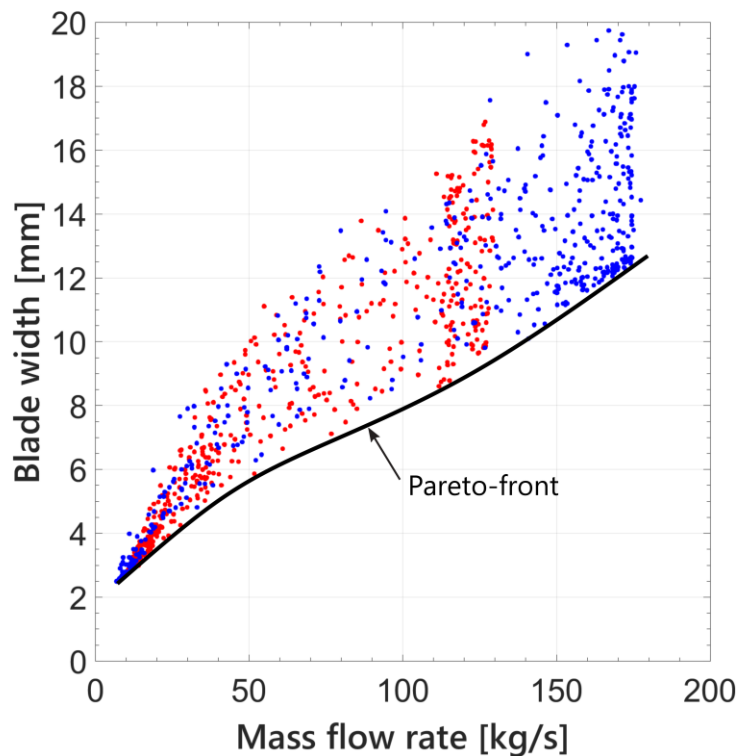
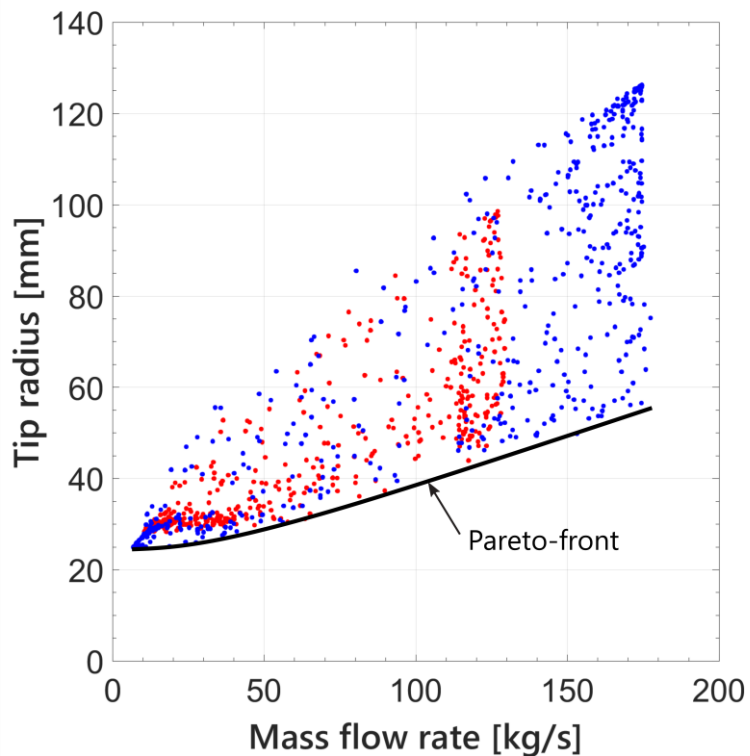

# Compressor Off-Design Performance Maps

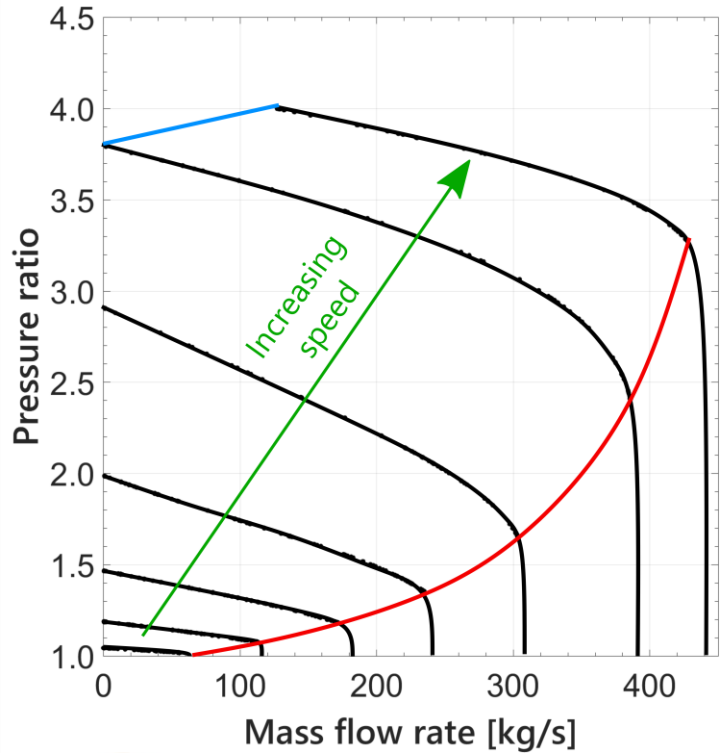
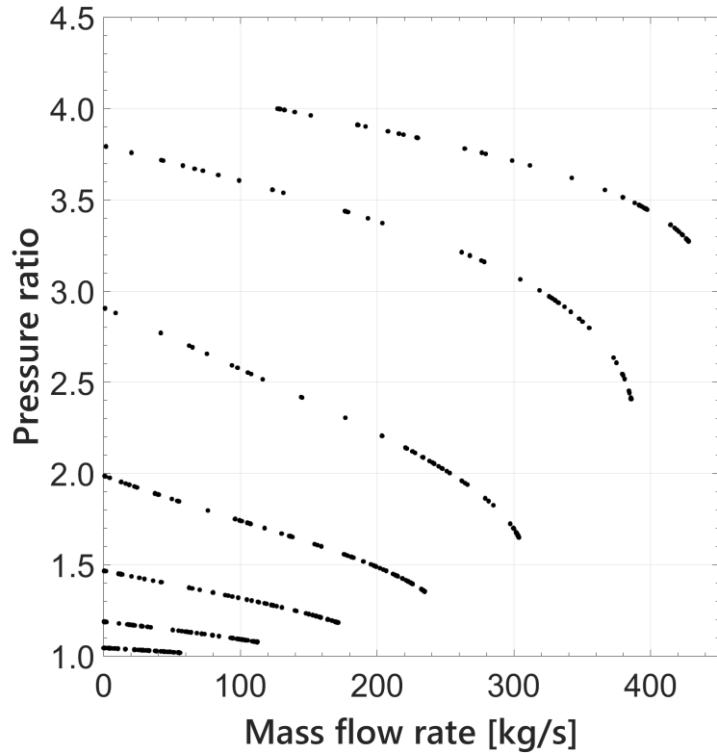

# Compressor Off-Design Performance Maps

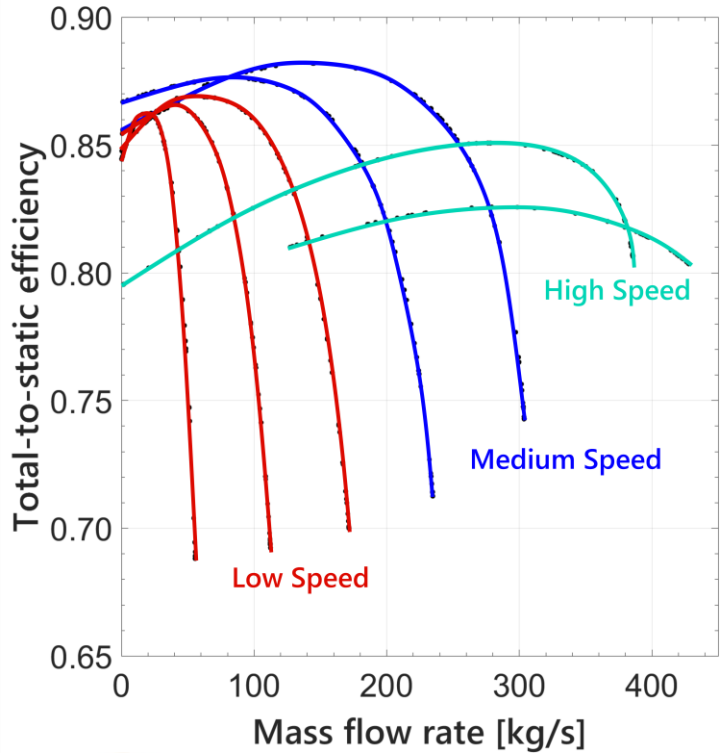
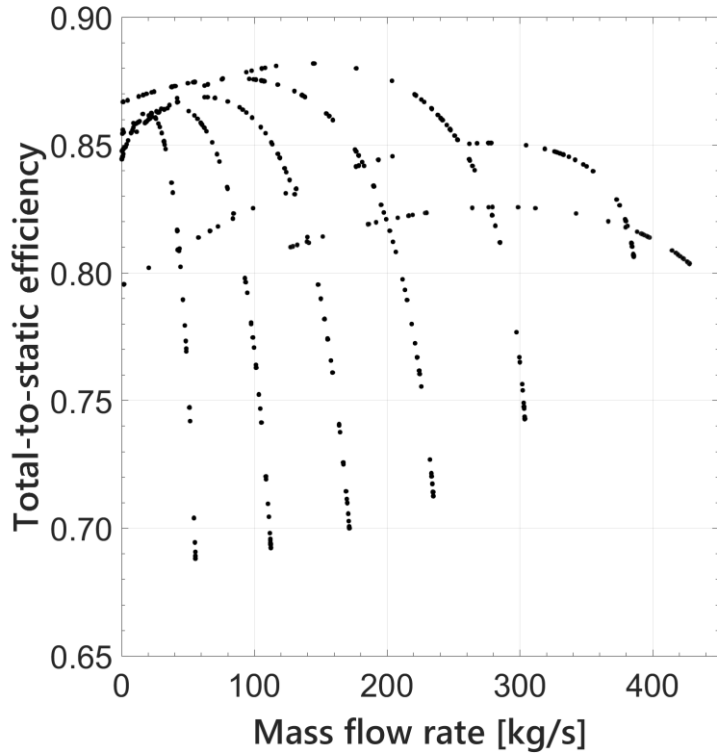

# General Findings

- Importance of a heuristics-based, sequential design procedure
  - from most influential aspects to least influential aspects (thermodynamics → turbomachinery → heat exchangers)
  - facilitates a fundamental understanding
  - significantly speeds-up computation
  - takes advantage of existing knowledge
- Dominance of turbomachinery
  - vast majority of the system's variables
  - inherent requirement of empirical data for loss modelling
  - complicated, non-linear performance and overwhelming mutual dependence of variables

# Image Credits



Dostal, V., Driscoll, M. & Hejzlar, P. 2004.

M. Utamura. [http://www.hyoka.koho.titech.ac.jp/eprd/recently/research/448\\_en.html](http://www.hyoka.koho.titech.ac.jp/eprd/recently/research/448_en.html)

<https://rapidmanufacturing.com/part-image-library/tubular-heat-sink/>

<https://www.indiamart.com/proddetail/power-spirit-turbo-charger-15780217788.html>

[http://heatexchanger.vpei.com/\\_images/product.png](http://heatexchanger.vpei.com/_images/product.png)

Schott® PTR70

Patnode, A.M., 2006

ESTELA, 2016

# Thanks

---

## ACKNOWLEDGEMENTS:

Solar Thermal Energy Research Group (STERG)

## CONTACT DETAILS:

**Ruan van der Westhuizen**  
Solar Thermal Energy Research  
Group (STERG)  
Stellenbosch University  
South Africa  
rvanderwesthuizen@sun.ac.za  
+27 (0)21 808 4016

**visit us: [concentrating.sun.ac.za](http://concentrating.sun.ac.za)**